

# DATA SHEET

Part No.	AN13208A
Package Code No.	ULGA020-L-0404

---

## Contents

■ Overview .....	3
■ Features .....	3
■ Applications .....	3
■ Package .....	3
■ Type .....	3
■ Application Circuit Example (Block Diagram) .....	4
■ Pin Descriptions .....	5
■ Absolute Maximum Ratings .....	6
■ Operating Supply Voltage Range .....	6
■ Electrical Characteristics .....	7
■ Electrical Characteristics (Reference values for design) .....	9
■ Technical Data .....	10
• I/O block circuit diagrams and pin function descriptions .....	10
• Operation table (LPFs) .....	14
• $P_D - T_a$ diagram .....	15
■ Usage Notes .....	16

# AN13208A

## 3-ch. video driver IC supporting HD with charge pump

### ■ Overview

AN13208A is a 75  $\Omega$  video driver IC supporting HD (high-definition) which can operate by 3.25 V of supply voltage.

Negative voltages generated by built-in charge pump circuit enable DC direct output, and output capacitor which is needed previously is not required. Also, it improves the output dynamic range which was difficult by a single supply.

Furthermore, it incorporates various filters for D pin outputs and control switches, which allows 75  $\Omega$  driving by 3 output systems of Cy, Cb, Cr or Py, Pb, Pr.

### ■ Features

- Supply voltage 3.25 V, 75  $\Omega$  driver for 3-ch. video
- 3 output systems of Cy, Cb, Cr or Py, Pb, Pr
- Supports D4 (720P)
- 3 modes of filter selector switches
- Built-in stand-by mode
- Output capacitor is unnecessary by generating negative voltage from charge pump circuit.
- Wide output dynamic range

### ■ Applications

- Video output for portable equipments such as DSC and DVC

### ■ Package

- 20 pin fine pitch land grid array package (LGA type)

### ■ Type

- Bi-CMOS IC

■ Application Circuit Example (Block Diagram)

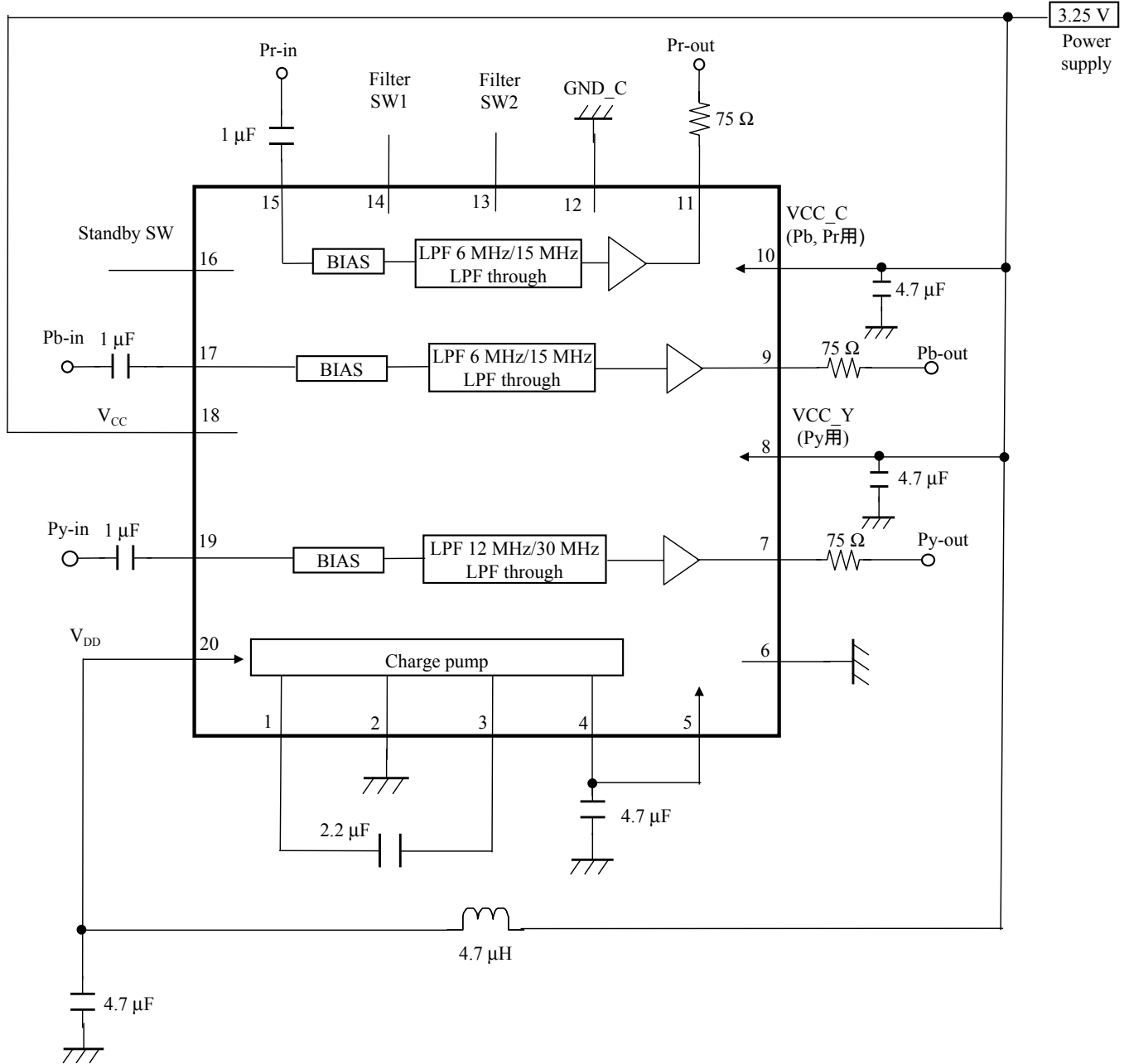

### ■ Pin Descriptions

Pin No.	Pin name	Type	Description
1	CLKP	Output	Clock output pin (+)
2	GND_PUMP	Ground	GND (for charge pump)
3	CLKN	Output	Clock output pin (-)
4	V <sub>SS</sub>	Output	Negative voltage generation pin
5	SUB	Input	SUB potential
6	GND_Y	Ground	GND (for Py)
7	Py-out	Output	Output pin for Py
8	VCC_Y	Power supply	V <sub>CC</sub> (for Py)
9	Pb-out	Output	Output pin for Pb
10	VCC_C	Power supply	V <sub>CC</sub> (for Pb/Pr)
11	Pr-out	Output	Output pin for Pr
12	GND_C	Ground	GND (for Pb/Pr)
13	Filter SW2	Input	Filter selector switch2
14	Filter SW1	Input	Filter selector switch1
15	Pr-in	Input	Input pin for Pr
16	Standby SW	Input	ON/OFF selector switch
17	Pb-in	Input	Input pin for Pb
18	V <sub>CC</sub>	Power supply	V <sub>CC</sub>
19	Py-in	Input	Input pin for Py
20	V <sub>DD</sub>	Power supply	V <sub>DD</sub> (for charge pump)

### ■ Absolute Maximum Ratings

A No.	Parameter	Symbol	Rating	Unit	Note
1	Supply voltage	$V_{CC}$	4.1	V	*1
2	Supply current	$I_{CC}$	—	A	—
3	Power dissipation	$P_D$	137	mW	*2
4	Operating ambient temperature	$T_{opr}$	-20 to +75	°C	*3
5	Storage temperature	$T_{stg}$	-55 to +125	°C	*3

Note) \*1: The range under absolute maximum ratings, power dissipation.

\*2: Power dissipation shows the value of only package at  $T_a = 75^\circ\text{C}$ .

When using this IC, refer to the •  $P_D - T_a$  diagram in the ■ Technical Data and use under the condition not exceeding the allowable value.

\*3: Expect for the storage temperature and operating ambient temperature, all ratings are for  $T_a = 25^\circ\text{C}$ .

### ■ Operating Supply Voltage Range

Parameter	Symbol	Range	Unit	Note
Supply voltage range	$V_{CC}$	2.7 to 3.6	V	—

Note) The values under the condition not exceeding the above absolute maximum ratings and the power dissipation.

### ■ Electrical Characteristics at $V_{CC} = 3.25\text{ V}$

Note)  $T_a = 25^\circ\text{C} \pm 2^\circ\text{C}$  unless otherwise specified.

B No.	Parameter	Symbol	Conditions	Limits			Unit	Note
				Min	Typ	Max		
<b>Circuit current</b>								
1	Circuit current at non-signal (Wide mode)	Icc1	—	—	50	70	mA	—
2	Circuit current in power saving mode	ICCST	$V_{13} = V_{14} = V_{16} = 0\text{ V}$	—	—	10	$\mu\text{A}$	—
<b>Mode control</b>								
3	Low state hold voltage range for filter selector switch1	SWL1	—	0	—	0.6	V	—
4	High state hold voltage range for filter selector switch1	SWH1	—	2.1	—	3.25	V	—
5	Low state hold voltage range for filter selector switch2	SWL2	—	0	—	0.6	V	—
6	High state hold voltage range for filter selector switch2	SWH2	—	2.1	—	3.25	V	—
7	Stand-by OFF hold voltage	VthST	—	0	—	0.6	V	—
8	Stand-by ON hold voltage	VthON	—	2.1	—	3.25	V	—
<b>Driver characteristics: Wide mode</b>								
9	Input/output gain (Py, wide mode)	Py1	$f = 3.58\text{ MHz}$	5.65	6.15	6.65	dB	—
10	Pb output gain difference (Pb-Py, wide mode)	Pb1	$f = 3.58\text{ MHz}$	-0.5	0	0.5	dB	—
11	Pr output gain difference (Pr-Py, wide mode)	Pr1	$f = 3.58\text{ MHz}$	-0.5	0	0.5	dB	—
<b>Driver characteristics: Narrow mode</b>								
12	Input/output gain (Py, narrow mode)	Py1	$f = 3.58\text{ MHz}$	5.65	6.15	6.65	dB	—
13	Pb output gain difference (Pb-Py, narrow mode)	Pb1	$f = 3.58\text{ MHz}$	-0.5	0	0.5	dB	—
14	Pr output gain (Pr-Py, narrow mode)	Pr1	$f = 3.58\text{ MHz}$	-0.5	0	0.5	dB	—
<b>Py frequency characteristics</b>								
15	Py <sub>a</sub> frequency character 1 (Wide mode)	Py <sub>a</sub> -f1	$f = 30\text{ MHz} / 3.58\text{ MHz}$	-3.5	-0.3	1.5	dB	—
16	Py <sub>a</sub> frequency character 2 (Wide mode)	Py <sub>a</sub> -f2	$f = 50\text{ MHz} / 3.58\text{ MHz}$	—	-13	-4.5	dB	—
17	Py <sub>b</sub> frequency character 1 (Narrow mode)	Py <sub>b</sub> -f1	$f = 15\text{ MHz} / 3.58\text{ MHz}$	-4	-1	1	dB	—
18	Py <sub>b</sub> frequency character 2 (Narrow mode)	Py <sub>b</sub> -f2	$f = 27\text{ MHz} / 3.58\text{ MHz}$	—	-20	-8	dB	—

■ Electrical Characteristics at  $V_{CC} = 3.25 \text{ V}$  (continued)

Note)  $T_a = 25^\circ\text{C} \pm 2^\circ\text{C}$  unless otherwise specified.

B No.	Parameter	Symbol	Conditions	Limits			Unit	Note
				Min	Typ	Max		
Pb frequency characteristics								
19	Pba frequency character 1 (Wide mode)	Pba-f1	f = 15 MHz / 3.58 MHz	-4	0	1	dB	—
20	Pba frequency character 2 (Wide mode)	Pba-f2	f = 37 MHz / 3.58 MHz	—	-25	-8	dB	—
21	Pbb frequency character 1 (Narrow mode)	Pbb-f1	f = 8 MHz / 3.58 MHz	-4	-0.2	1	dB	—
22	Pbb frequency character 2 (Narrow mode)	Pbb-f2	f = 18 MHz / 3.58 MHz	—	-16	-6	dB	—
Pr frequency characteristics								
23	Pra frequency character 1 (Wide mode)	Pra-f1	f = 15 MHz / 3.58 MHz	-4	0	1	dB	—
24	Pra frequency character 2 (Wide mode)	Pra-f2	f = 37 MHz / 3.58 MHz	—	-25	-8	dB	—
25	Prb frequency character 2 (Narrow mode)	Prb-f2	f = 8 MHz / 3.58 MHz	-4.0	-0.2	1	dB	—
26	Prb frequency character 2 (Narrow mode)	Prb-f2	f = 18 MHz / 3.58 MHz	—	-16	-6	dB	—

### ■ Electrical Characteristics (Reference values for design) at $V_{CC} = 3.25\text{ V}$

Note)  $T_a = 25^\circ\text{C} \pm 2^\circ\text{C}$  unless otherwise specified.

The characteristics listed below are reference values for design of the IC and are not guaranteed by inspection.





If a problem does occur related to these characteristics, Panasonic will respond in good faith to user concerns.

B No.	Parameter	Symbol	Conditions	Limits			Unit	Note
				Min	Typ	Max		
Py, Pb, Pr frequency characteristics								
27	Py <sub>a</sub> frequency character 3 (Wide mode)	Py <sub>a</sub> -f3	f = 74 MHz / 3.58 MHz	—	-40	-30	dB	—
28	Py <sub>b</sub> frequency character 3 (Narrow mode)	Py <sub>b</sub> -f3	f = 54 MHz / 3.58 MHz	—	-50	-30	dB	—
29	Pb <sub>a</sub> frequency character 3 (Wide mode)	Pb <sub>a</sub> -f3	f = 54 MHz / 3.58 MHz	—	-40	-30	dB	—
30	Pb <sub>b</sub> frequency character 3 (Narrow mode)	Pb <sub>b</sub> -f3	f = 54 MHz / 3.58 MHz	—	-45	-30	dB	—
31	Pra frequency character 3 (Wide mode)	Pra-f3	f = 54 MHz / 3.58 MHz	—	-40	-30	dB	—
32	Pr <sub>b</sub> frequency character 3 (Narrow mode)	Pr <sub>b</sub> -f3	f = 54 MHz / 3.58 MHz	—	-45	-30	dB	—
Py, Pb, Pr output characteristics								
33	Py output 2nd distortion	Py-Dis2	$V_{IN} = 1.0\text{ V[p-p]}$ , f = 3.58 MHz	—	-45	-40	dB	—
34	Py output 3rd distortion	Py-Dis3	$V_{IN} = 1.0\text{ V[p-p]}$ , f = 3.58 MHz	—	-60	-40	dB	—
35	Pb output 2nd distortion	Pb-Dis2	$V_{IN} = 1.0\text{ V[p-p]}$ , f = 3.58 MHz	—	-45	-40	dB	—
36	Pb output 3rd distortion	Pb-Dis3	$V_{IN} = 1.0\text{ V[p-p]}$ , f = 3.58 MHz	—	-60	-40	dB	—
37	Pr output 2nd distortion	Pr-Dis2	$V_{IN} = 1.0\text{ V[p-p]}$ , f = 3.58 MHz	—	-45	-40	dB	—
38	Pr output 3rd distortion	Pr-Dis3	$V_{IN} = 1.0\text{ V[p-p]}$ , f = 3.58 MHz	—	-60	-40	dB	—
39	S/N	SNR	white50%, 100 kHz-4.2 MHz, Trap = off	60	—	—	dB	—
40	DG	DG	$V_{IN} = 1.0\text{ V[p-p]}$ , 10 STEP	—	1	—	%	—
41	DP	DP	$V_{IN} = 1.0\text{ V[p-p]}$ , 10 STEP	—	1	—	DEG	—
42	Cross talk	CT	5 MHz	—	—	-50	dB	—
43	Output D-range	DROUT	f = 1 MHz	—	4.0	—	V	—
44	Input D-range	DRIN	f = 1 MHz	—	2.0	—	V	—

### ■ Technical Data

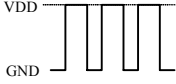
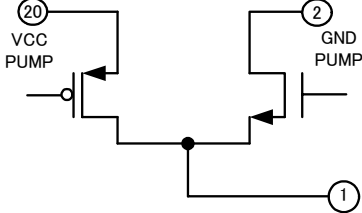
- I/O block circuit diagrams and pin function descriptions

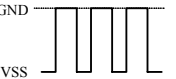
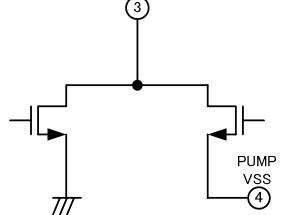
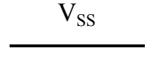
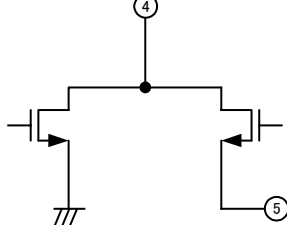
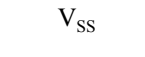



Note) The characteristics listed below are reference values based on the IC design and are not guaranteed.

Pin No.	Waveform and voltage	Internal circuit	Impedance	Description
1			—	Generated negative voltage output pin 1
2		—	—	GND for charge pump
3			—	Generated negative voltage output pin 2
4			—	Negative voltage generation pin
5		—	—	SUB potential
6		—	—	GND (for Py)

### ■ Technical Data (continued)

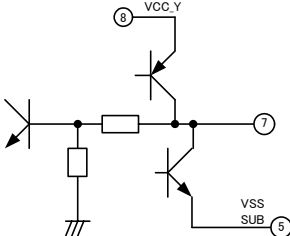
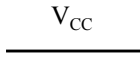
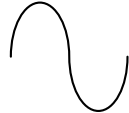
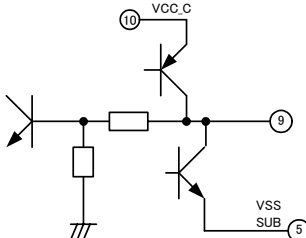
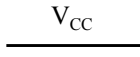
#### • I/O block circuit diagrams and pin function descriptions (continued)

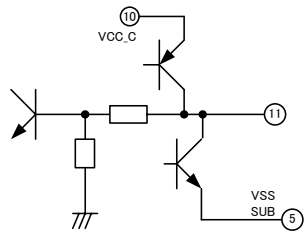
Note) The characteristics listed below are reference values based on the IC design and are not guaranteed.

Pin No.	Waveform and voltage	Internal circuit	Impedance	Description
7			During operation 10 $\Omega$ or less	Py-out
8		—	—	V <sub>CC</sub> (for Py)
9			During operation 10 $\Omega$ or less	Pb-out
10		—	—	V <sub>CC</sub> (for Pb/Pr)
11			During operation 10 $\Omega$ or less	Pr-out
12		—	—	GND (for Pb/Pr)

### ■ Technical Data (continued)

#### • I/O block circuit diagrams and pin function descriptions (continued)

Note) The characteristics listed below are reference values based on the IC design and are not guaranteed.

Pin No.	Waveform and voltage	Internal circuit	Impedance	Description
13	$V_{CC}$  <u>GND</u>		200 kΩ	Filter control switch 2
14	$V_{CC}$  <u>GND</u>		200 kΩ	Filter control switch 1
15			130 kΩ	Pr-in
16	$V_{CC}$  <u>GND</u>		200 kΩ	Stand-by control switch 1
17			130 kΩ	Pb-in
18	<u><math>V_{CC}</math></u>	—	—	$V_{CC}$

■ Technical Data (continued)

- I/O block circuit diagrams and pin function descriptions (continued)

Note) The characteristics listed below are reference values based on the IC design and are not guaranteed.

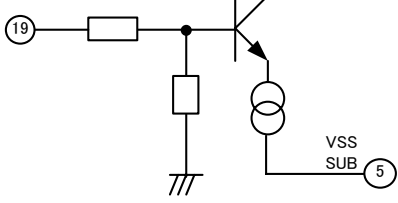
Pin No.	Waveform and voltage	Internal circuit	Impedance	Description
19			130 k $\Omega$	Py-in
20	$V_{CC}$	—	—	$V_{DD}$ (for charge pump)

■ Technical Data (continued)

• Operation table (LPFs)

Pin setting			Operating conditions
Pin 16 Standby SW	Pin 14 Filter SW1	Pin 13 Filter SW2	
0	0	0	Stand-by (normal)
		1	(Stand-by)
	1	0	(Stand-by)
		1	(Stand-by)
1	0	0	Circuit operation (LPF1: Wide)
		1	Circuit operation (LPF2: Narrow)
	1	0	Circuit operation (Through: Filter through mode)
		1	Circuit operation (Through: Filter through mode)

■ Technical Data (continued)

- $P_D - T_a$  diagram

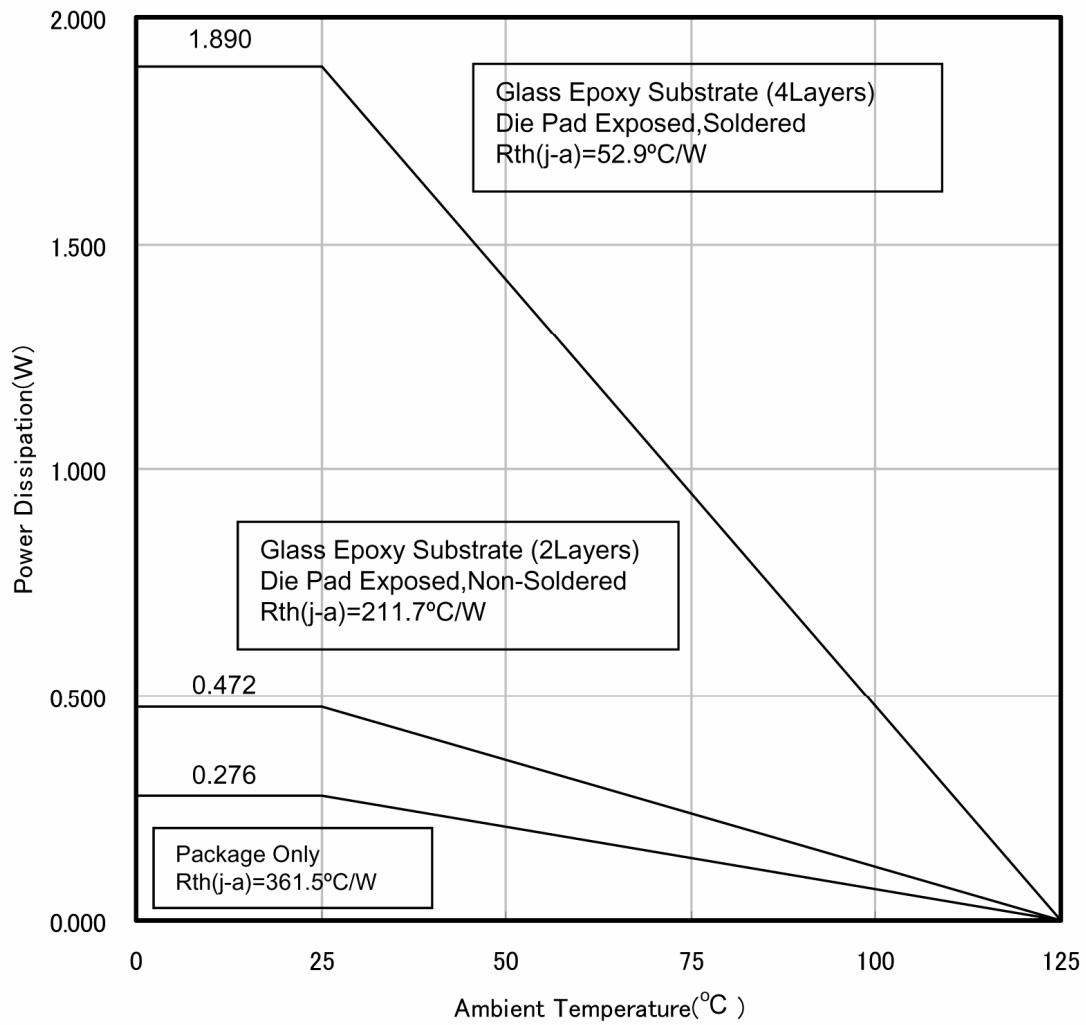

**■ Usage Notes**

1. Carry out the thermal design with sufficient margin such that the power dissipation will not be exceeded, based on the conditions of power supply, load and ambient temperature. The absolute maximum ratings are values which should not be exceeded in any use or test conditions.
2. Pay attention in the pattern layout in order to prevent damage due to short circuit between pins. In addition, refer to the ■ Pin Description for the pin configuration.
3. Be sure not to mount the LSI in the reverse direction onto the PCB. It might be damaged when the electricity is turned on.
4. Perform a visual inspection on the PCB before turning on the power supply, otherwise damage might happen due to problems such as a solder-bridge between the pins of the semiconductor device. Also, perform a full technical verification on the assembly quality, because the same damage possibly can happen due to conductive substances, such as solder ball, that adhere to the LSI during transportation.
5. Take notice in the use of this product that it might break or occasionally smoke when an abnormal state occurs such as power fault, i.e., output pins, Pin4 (CP negative voltage output), or Pin5 (SUB potential) short to the power supplies. And, safety measures such as an installation of fuses are recommended because the extent of the above-mentioned damage and smoke emission will depend on the current capability of the power supply.
6. When using the LSI for model deployment or new products, perform fully safety verification including the long-term reliability for each product.
7. This IC has a built-in charge pump which generates PCB voltage (negative voltage) inside the IC. As the fin of this IC is connected to the PCB, it might be damaged or emit smoke when a voltage including GND is applied.

## Request for your special attention and precautions in using the technical information and semiconductors described in this book

- (1) If any of the products or technical information described in this book is to be exported or provided to non-residents, the laws and regulations of the exporting country, especially, those with regard to security export control, must be observed.
- (2) The technical information described in this book is intended only to show the main characteristics and application circuit examples of the products. No license is granted in and to any intellectual property right or other right owned by Panasonic Corporation or any other company. Therefore, no responsibility is assumed by our company as to the infringement upon any such right owned by any other company which may arise as a result of the use of technical information described in this book.
- (3) The products described in this book are intended to be used for standard applications or general electronic equipment (such as office equipment, communications equipment, measuring instruments and household appliances).  
Consult our sales staff in advance for information on the following applications:
  - Special applications (such as for airplanes, aerospace, automobiles, traffic control equipment, combustion equipment, life support systems and safety devices) in which exceptional quality and reliability are required, or if the failure or malfunction of the products may directly jeopardize life or harm the human body.
  - Any applications other than the standard applications intended.
- (4) The products and product specifications described in this book are subject to change without notice for modification and/or improvement. At the final stage of your design, purchasing, or use of the products, therefore, ask for the most up-to-date Product Standards in advance to make sure that the latest specifications satisfy your requirements.
- (5) When designing your equipment, comply with the range of absolute maximum rating and the guaranteed operating conditions (operating power supply voltage and operating environment etc.). Especially, please be careful not to exceed the range of absolute maximum rating on the transient state, such as power-on, power-off and mode-switching. Otherwise, we will not be liable for any defect which may arise later in your equipment.
  - Even when the products are used within the guaranteed values, take into the consideration of incidence of break down and failure mode, possible to occur to semiconductor products. Measures on the systems such as redundant design, arresting the spread of fire or preventing glitch are recommended in order to prevent physical injury, fire, social damages, for example, by using the products.
- (6) Comply with the instructions for use in order to prevent breakdown and characteristics change due to external factors (ESD, EOS, thermal stress and mechanical stress) at the time of handling, mounting or at customer's process. When using products for which damp-proof packing is required, satisfy the conditions, such as shelf life and the elapsed time since first opening the packages.
- (7) This book may be not reprinted or reproduced whether wholly or partially, without the prior written permission of our company.